



## MULTI HORNET (ORG1518R-01)

### EVALUATION KIT (ORG1518-UAR)

## Datasheet



## INDEX

1.	SCOPE .....	4
2.	DISCLAIMER .....	4
3.	SAFETY INFORMATION .....	4
4.	ESD SENSITIVITY .....	4
5.	CONTACT INFORMATION .....	4
6.	RELATED DOCUMENTATION .....	4
7.	REVISION HISTORY .....	5
8.	ABOUT HORNET FAMILY .....	5
9.	ABOUT MULTI MICRO HORNET MODULE .....	5
10.	ABOUT ORIGINGPS.....	6
11.	DESCRIPTION .....	6
12.	SCHEMATICS .....	7
12.1.	MAIN BOARD SCHEMATICS.....	7
12.2.	INTERFACE ADAPTOR SCHEMATICS .....	8
13.	BILL OF MATERIALS .....	9
13.1.	MAIN BOARD BILL OF MATERIALS .....	9
13.2.	INTERFACE ADAPTOR BILL OF MATERIALS.....	9
14.	ASSEMBLY AND LAYOUT .....	10
14.1.	MAIN BOARD PCB .....	10
14.2.	INTERFACE ADAPTOR PCB.....	12
15.	TTL-232R-3V3 USB-Serial CONVERTER CABLE.....	15

## TABLE INDEX

TABLE 1 – RELATED DOCUMENTATION.....	4
TABLE 2 – REVISION HISTORY.....	5
TABLE 3 – MAIN BOARD BILL OF MATERIALS.....	9
TABLE 4 – INTERFACE ADAPTOR BILL OF MATERIALS .....	9
TABLE 5 – USB-SERIAL CONVERTER CABLE HEADER PIN-OUT .....	15
TABLE 6 – USB-SERIAL CONVERTER CABLE OPERATING PARAMETERS .....	15



## FIGURE INDEX

FIGURE 1 – MAIN BOARD SCHEMATICS .....	7
FIGURE 2 – INTERFACE ADAPTOR SCHEMATICS.....	8
FIGURE 3 – MAIN BOARD COMPONENTS PLACEMENT .....	10
FIGURE 4 – MAIN BOARD SOLDER MASK .....	10
FIGURE 5 – MAIN BOARD TOP LAYER ROUTING .....	11
FIGURE 6 – MAIN BOARD BOTTOM LAYER ROUTING .....	11
FIGURE 7 – INTERFACE ADAPTOR BOARD COMPONENTS PLACEMENT .....	12
FIGURE 8 – INTERFACE ADAPTOR BOARD SOLDER MASK.....	12
FIGURE 9 – INTERFACE ADAPTOR BOARD TOP LAYER ROUTING .....	13
FIGURE 10 – INTERFACE ADAPTOR INNER LAYER 1 ROUTING .....	13
FIGURE 11 – INTERFACE ADAPTOR INNER LAYER 2 ROUTING .....	14
FIGURE 12 – INTERFACE ADAPTOR BOTTOM LAYER ROUTING.....	14
FIGURE 13 – PIN HEADER SOCKET BOTTOM VIEW .....	15



## 1. SCOPE

This document describes the features and specifications of Multi Micro Hornet ORG1518-R01 evaluation kit.

## 2. DISCLAIMER

All trademarks are properties of their respective owners.

Performance characteristics listed in this document do not constitute a warranty or guarantee of product performance. OriginGPS assumes no liability or responsibility for any claims or damages arising out of the use of this document, or from the use of integrated circuits based on this document.

OriginGPS assumes no liability or responsibility for unintentional inaccuracies or omissions in this document.

OriginGPS reserves the right to make changes in its products, specifications and other information at any time without notice.

OriginGPS reserves the right to conduct, from time to time, and at its sole discretion, firmware upgrades.

As long as those FW improvements have no material change on end customers, PCN may not be issued.

OriginGPS navigation products are not recommended to use in life saving or life sustaining applications.

## 3. SAFETY INFORMATION

Improper handling and use can cause permanent damage to the product.

## 4. ESD SENSITIVITY

This product is ESD sensitive device and must be handled with care.



## 5. CONTACT INFORMATION

Support - [support@origingps.com](mailto:support@origingps.com)

Marketing and sales - [marketing@origingps.com](mailto:marketing@origingps.com)

Web – [www.origingps.com](http://www.origingps.com)

## 6. RELATED DOCUMENTATION

No	DOCUMENT NAME
1	Multi Micro Hornet – ORG1518-R-01 Datasheet

TABLE 1 – RELATED DOCUMENTATION



## 7. REVISION HISTORY

REVISION	DATE	CHANGE DESCRIPTION
1.0	September 2, 2018	First release

TABLE 2 – REVISION HISTORY

## 8. ABOUT HORNET FAMILY

OriginGPS GNSS receiver modules have been designed to address markets where size, weight, stand-alone operation, highest level of integration, power consumption and design flexibility - all are very important. OriginGPS' Hornet family breaks size barrier, offering the industry's smallest fully-integrated, highly-sensitive GPS and GNSS modules with integrated antennas or on-board RF connectors.

Hornet family features OriginGPS' proprietary NFZ™ technology for high sensitivity and noise immunity even under marginal signal condition, commonly found in urban canyons, under dense foliage or when the receiver's position in space rapidly changes.

Hornet family enables the shortest TTM (Time-To-Market) with minimal design risks.

Just connect power supply on a single layer PCB.

## 9. ABOUT MULTI MICRO HORNET MODULE

Multi Micro Hornet is a complete SiP featuring miniature LGA SMT footprint designed to commit unique integration features for high volume cost sensitive applications.

Designed to support compact and traditional applications such as smart watches, wearable devices, asset trackers, Multi Micro Hornet ORG1518R-01 module is a multi-channel GPS/ GLONASS with SBAS, QZSS and other regional overlay systems receiver that continuously tracks all satellites in view, providing real-time positioning data in industry's standard NMEA format.

Multi Micro Hornet ORG1518R01 module offers superior sensitivity and outstanding performance, achieving rapid TTFF in less than one second, accuracy of approximately two meters, and tracking sensitivity of -167dBm.

Sized only 18mm x 18mm Multi Micro Hornet ORG1518R-01 module is industry's small sized, record breaking solution.

Multi Micro Hornet module integrates OriginGPS proprietary on-board GNSS antenna, dual-stage LNA, RF LDO, SAW filter, TCXO, RTC crystal and RF shield with market-leading CSRG0530B01-ICKD-R GNSS SoC.

Multi Micro Hornet ORG1518R-01 module is introducing industry's lowest energy per fix ratio, unparalleled accuracy and extremely fast fixes even under challenging signal conditions, such as in built-up urban areas, dense foliage or even indoor.

Integrated GNSS SoC incorporating high-performance microprocessor and sophisticated firmware keeps positioning payload off the host, allowing integration in embedded solutions with low computing resources.

Innovative architecture can detect changes in context, temperature, and satellite signals to achieve a state of near continuous availability by maintaining and opportunistically updating its internal fine time, frequency, and satellite ephemeris data while consuming mere microwatts of battery power.



## 10. ABOUT ORIGINGPS

OriginGPS is a world leading designer, manufacturer and supplier of miniature positioning modules, antenna modules and antenna solutions.

OriginGPS modules introduce unparalleled sensitivity and noise immunity by incorporating Noise Free Zone system (NFZ™) proprietary technology for faster position fix and navigation stability even under challenging satellite signal conditions.

Founded in 2006, OriginGPS is specializing in development of unique technologies that miniaturize RF modules, thereby addressing the market need for smaller wireless solutions.

## 11. DESCRIPTION

Evaluation Kit of the ORG1518-R01 GNSS Antenna Module comprises the Demo Board, USB to UART cable and CD with GPS simulator software for PC and documentation.

The Demo Board is built of Main Board, incorporating 1.8V LDO regulator, UART connector, push-button and various test points.

The ORG1518-R-01 GNSS Antenna Module is soldered onto the Main Board through the Interface Adaptor.

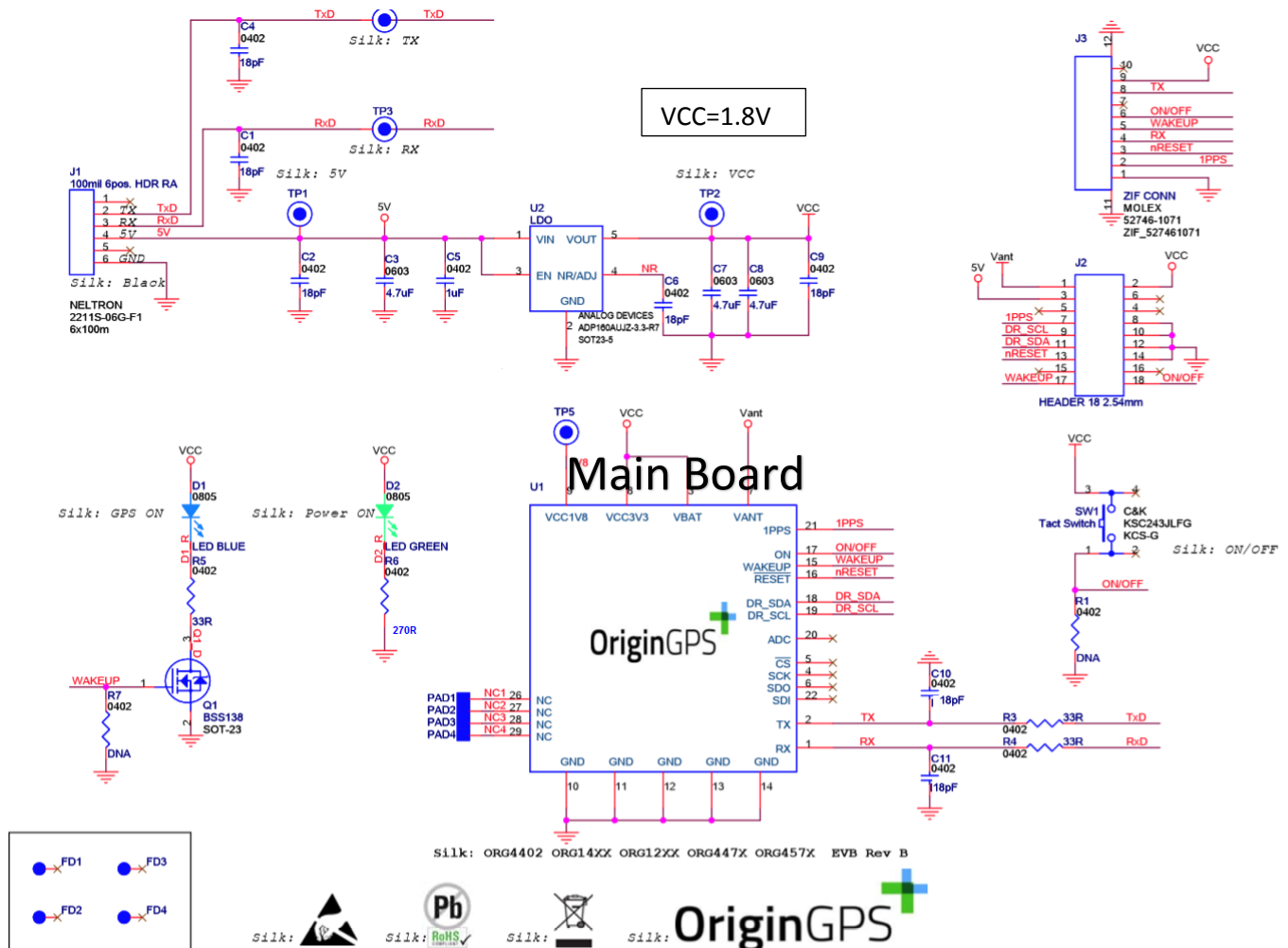



## 13. BILL OF MATERIALS

### 13.1 MAIN BOARD BILL OF MATERIALS

Reference	Value	Description	P/N	MFG
C1, C2, C6, C9 C10, C11	18pF	CAP SMT 0402 18pF ±5% 50V COG	GRM1555C1H180JZ01D	MURATA
C3,C7,C8	4.7µF	CAP SMT 0603 4.7µF ±10% 6.3V X5R	GRM188R60J475KE19D	MURATA
C5	1µF	CAP SMT 0402 1µF ±10% 10V X5R	GRM155R61A105KE15D	MURATA
D1	LED BLUE	LED BLUE SMT 0805 20mA	APT2012QBC/D	KINGBRIGHT
J3	ZIF CONN	10pos. 0.5mm pitch FPC ZIF SMT Conn.	52746-1071	MOLEX
Q1	BSS138	N-CH 0.2A 50V SOT23 Power MOSFET	BSS138LT1G	ON
R3, R4, R5	33R	RES SMT 0402 33R ±1%	RM04FTN033R	TA-I
R6	270R	RES SMT 0402 270R ±1%	RM04FTN270R	TA-I
J1	HDR	HEADER 6 POS. "0.1 RIGHT ANGLE	2211S-06G-F1	NELTRON
U1	LDO	3.3V 200mA LDO W. Discharge Reg. SOT23	ADP160AUJZ-3.3-R7	AD
J2	Connector	18 pins connector		

TABLE 3 - MAIN BOARD BILL OF MATERIALS

### 13.2 INTERFACE ADAPTOR BILL OF MATERIALS

Reference	Value	Description	P/N	MFG
C1	18pF	CAP SMT 0402 18pF ±5% 50V COG	GRM1555C1H180JZ01D	MURATA
C4	100nF	CAP SMT 0402 100nF ±10% 16V X7R	GRM155R71C104KA88D	MURATA
C2,C3	1µF	CAP SMT 0402 1µF ±10% 10V X5R	GRM155R61A105KE15D	MURATA
R5	100Ω	RES SMT 0402 100Ω ±1%	RM04FTN1000	TA-I
R1,R2,R3, R4, R6	10KΩ	RES SMT 0402 10KΩ ±1%	RM04FTN1002	TA-I
R7	100KΩ	RES SMT 0402 100KΩ ±1%	RM04FTN1003	TA-I
Q1	2N7002	N-CH MOSFET SOT-23	2N7002KT1G	ON
U1	MODULE	GNSS ANTENNA MODULE SMT LGA	ORG1510 -MK-04	ORIGINGPS
U2	NLU1GT126	SINGLE BUFFER 3-STATE	NLU1GT126CMX1TCG	ON
U3	TPS3808	LOW IQ POR SUPERVISOR W. MAN. RST	TPS3808G18DRVVR	TI

TABLE 4 - INTERFACE ADAPTOR BILL OF MATERIALS





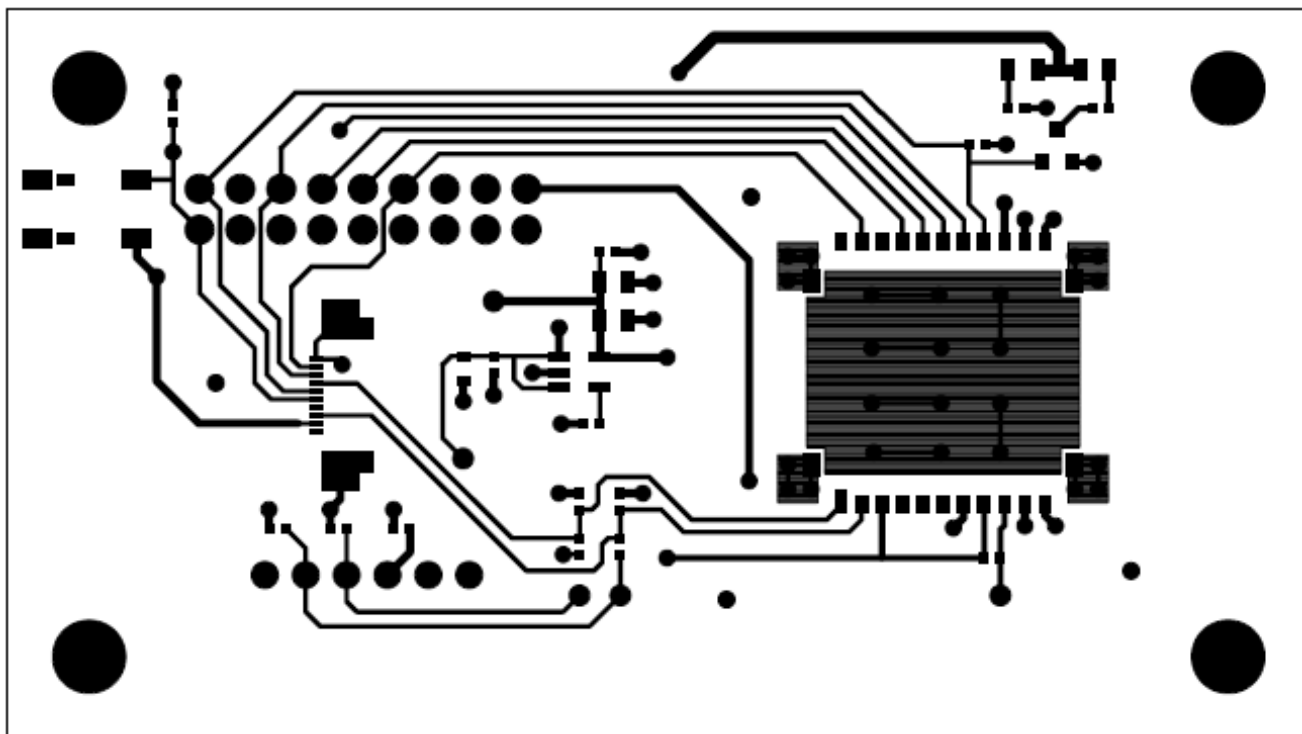

FIGURE 5 – MAIN BOARD TOP LAYER ROUTING

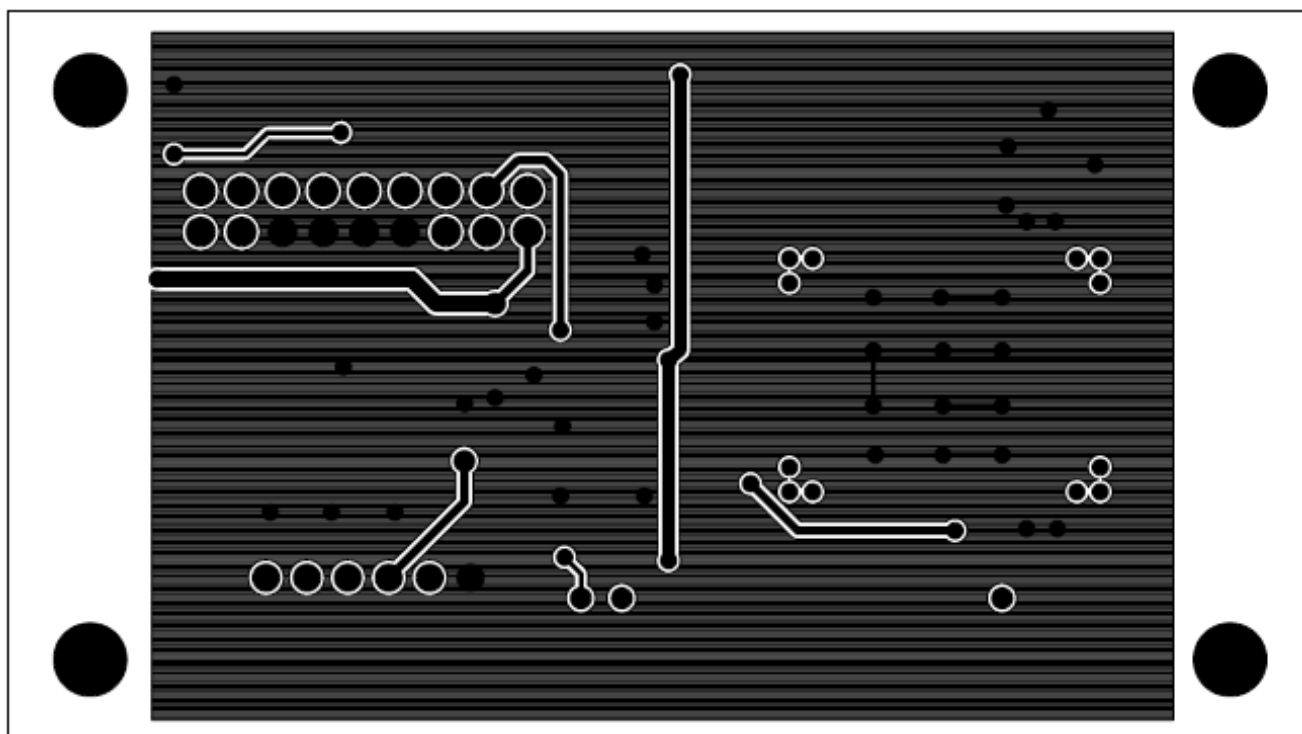

FIGURE 6 – MAIN BOARD BOTTOM LAYER ROUTING



### 14.2 INTERFACE ADAPTOR PCB

Interface Adaptor Board for the ORG1518-R01 GNSS Antenna Module is 17mm x 17mm 22 pads 4 layers 0.6mm thickness FR4 PCB.

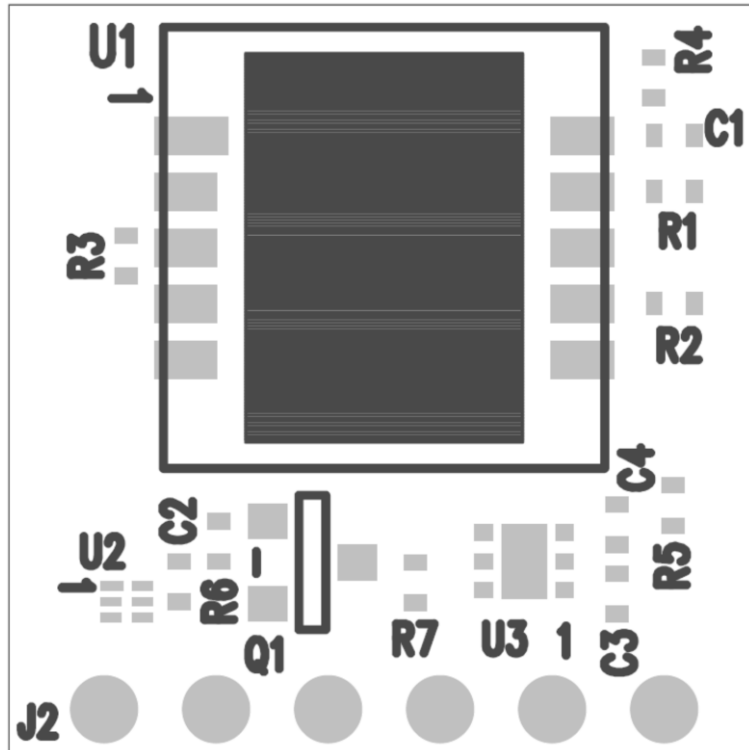

FIGURE 7 - INTERFACE ADAPTOR BOARD COMPONENTS PLACEMENT

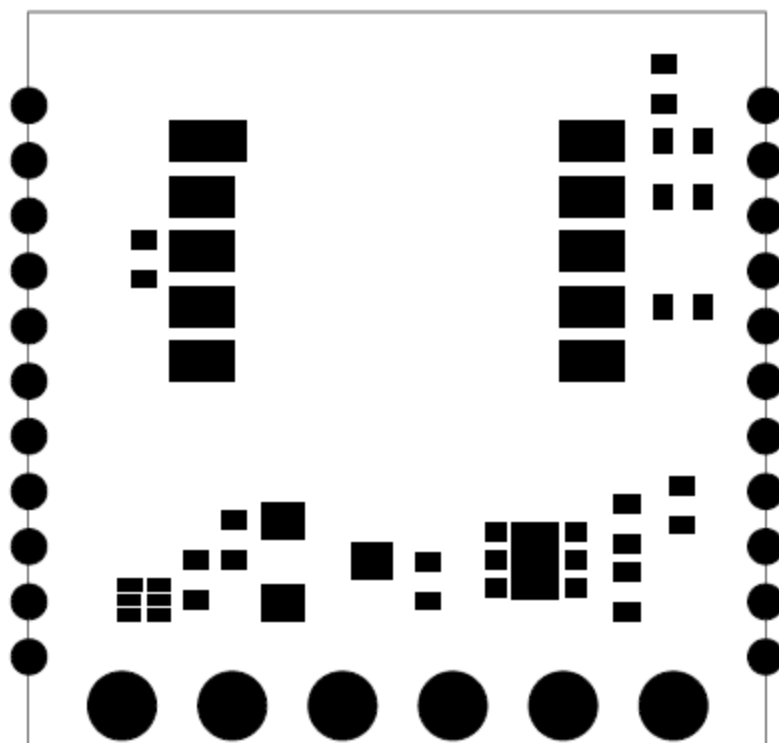

FIGURE 8 - INTERFACE ADAPTOR BOARD SOLDER MASK

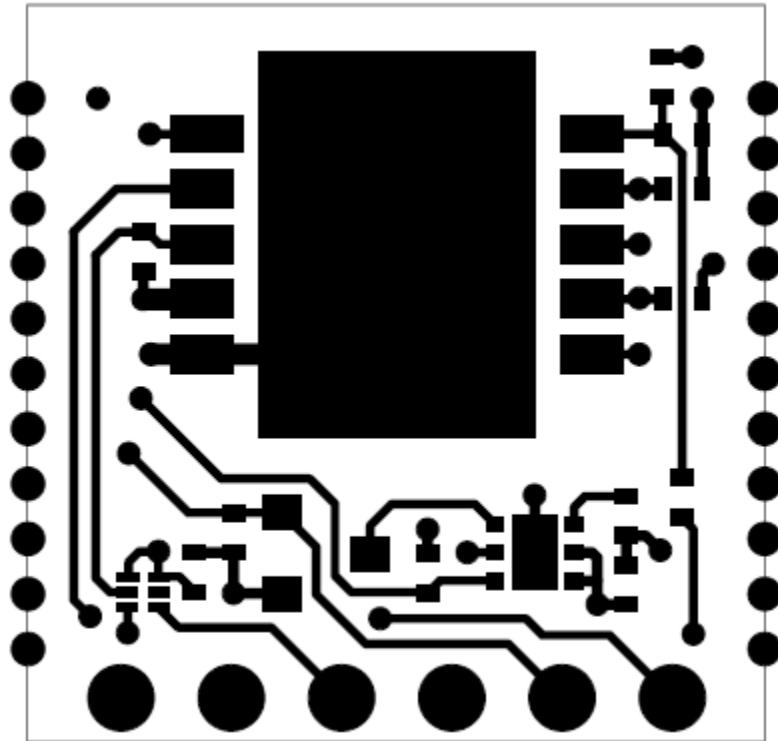
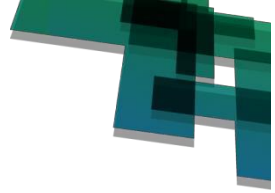

FIGURE 9 - INTERFACE ADAPTOR BOARD TOP LAYER ROUTING

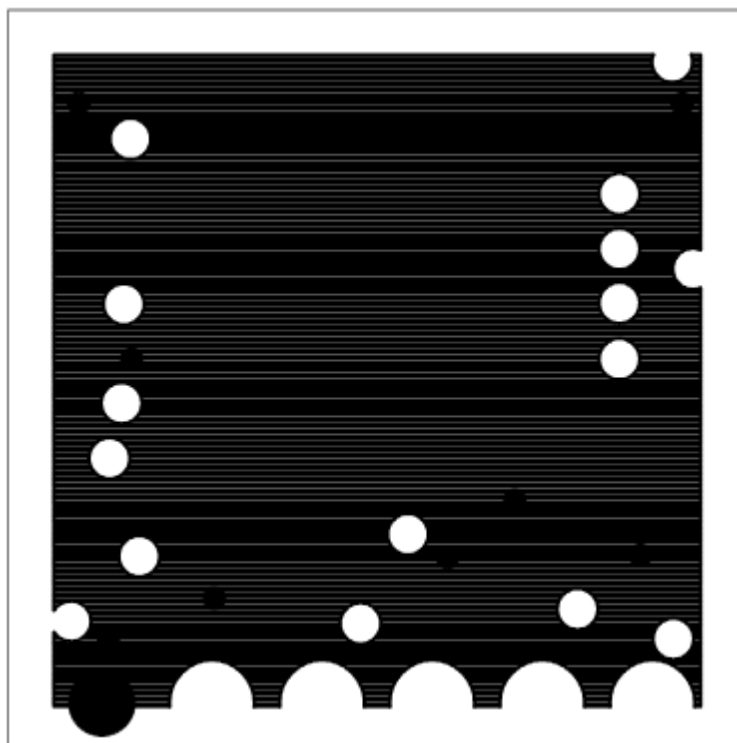

FIGURE 10 - INTERFACE ADAPTOR INNER LAYER 1 ROUTING

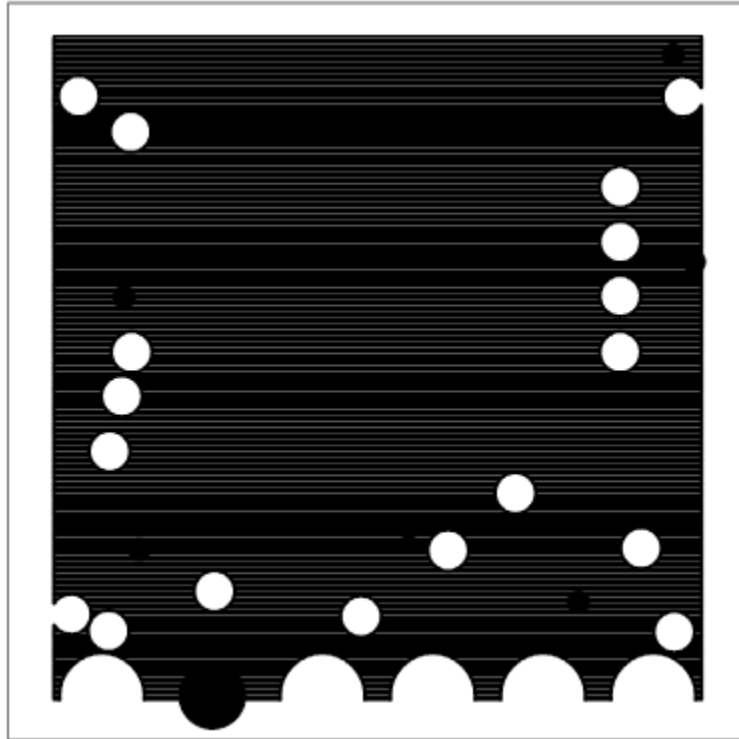

FIGURE 11 - INTERFACE ADAPTOR INNER LAYER 2 ROUTING

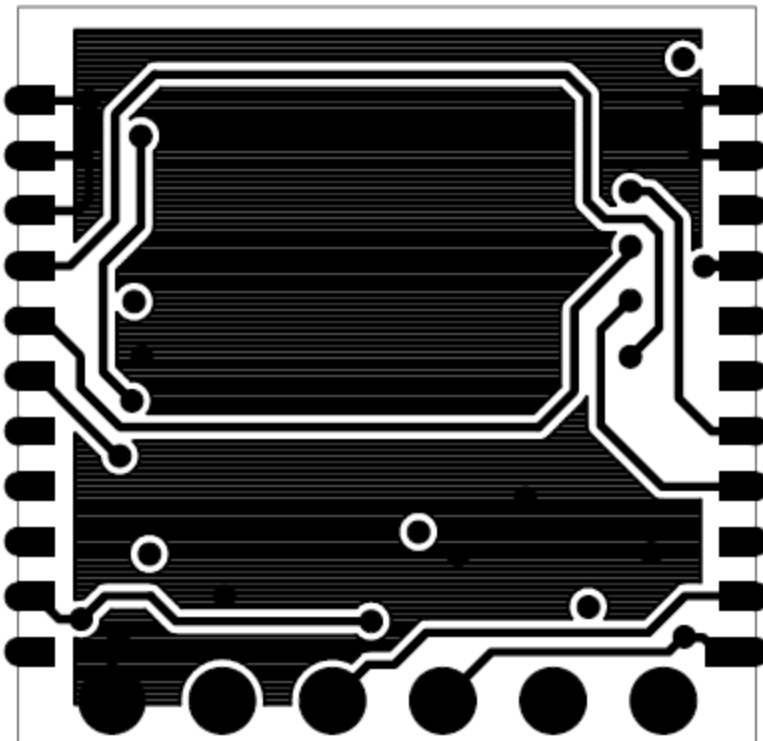

FIGURE 12 - INTERFACE ADAPTOR BOTTOM LAYER ROUTING



## 15. TTL-232R-3V3 USB-Serial CONVERTER CABLE\*

The TTL-232R-3V3 is a USB to Serial converter cable that provides a simple way to connect devices with UART interface to PC.

The TTL-232R-3V3 uses an FTDI FT232RQ IC which is housed inside the USB Type 'A' connector and is terminated at the end of a 1.8 meter cable (6 ft.) with a 2.54mm ("0.1) pitch header socket which provides an access to UART standard Transmit Data (TxD) and Receive Data (RxD). These lines are operating at 3.3V LVTTTL levels. Also brought out on the header are +5V and GND.



FIGURE 13 - PIN HEADER SOCKET BOTTOM VIEW

Pin Number	Name	Type	Colour	Description
1	GND	Power	Black	Ground supply pin
2	CTS	Input	Brown	Clear To Send input – not in use
3	VCC	Power	Red	+5V power source, USB specified
4	TXD	Output	Orange	Asynchronous Data output – GPS input
5	RXD	Input	Yellow	Asynchronous Data input – GPS output
6	RTS	Output	Green	Request To Send output – not in use

TABLE 5 - USB-SERIAL CONVERTER CABLE HEADER PIN-OUT

Parameter	Symbol	Test Conditions	Min	Typ	Max	Units
Power Supply Voltage	$V_{CC}$	Defined by USB $V_{BUS}$	4.25	5.0	5.25	V
Power Supply Current	$I_o$		-	-	75	mA
Output Voltage Low State	$V_{OL}$	$I_{OL} = 8mA$	0.3	0.4	0.6	V
Output Voltage High State	$V_{OH}$	$I_{OH} = -3mA$	2.2	2.8	3.2	V
Input Voltage State Switching Threshold	$V_{IN}$	Low $\rightarrow$ High	1.0	1.2	1.5	V
Input Voltage State Switching Hysteresis	$V_{HYST}$	High $\rightarrow$ Low	20	25	30	mV
Operating Temperature	$T_{AMB}$		-40	+25	+85	$^{\circ}C$

TABLE 6 - USB-SERIAL CONVERTER CABLE OPERATING PARAMETERS

\*Note: For more information refer to FTDI Ltd. TTL-232R TTL To USB Serial Converter Range Of Cables Datasheet, Document Reference No.: FT\_000054